

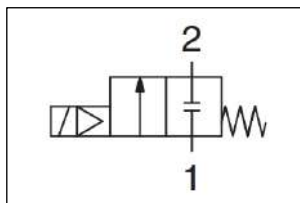

ORIGINAL INSTRUCTIONS

## Instruction Manual

## Zero Differential Pilot - 2 Port Solenoid Valve Series JSXZ



The intended use of this product is to control the downstream fluid supply.

## 1 Safety Instructions

These safety instructions are intended to prevent hazardous situations and/or equipment damage. These instructions indicate the level of potential hazard with the labels of "Caution," "Warning" or "Danger." They are all important notes for safety and must be followed in addition to International Standards (ISO/IEC<sup>1)</sup>, and other safety regulations.

- <sup>1)</sup> ISO 4414: Pneumatic fluid power - General rules relating to systems.  
ISO 4413: Hydraulic fluid power - General rules relating to systems.  
IEC 60204-1: Safety of machinery - Electrical equipment of machines. (Part 1: General requirements)  
ISO 10218-1: Robots and robotic devices - Safety requirements for industrial robots - Part 1: Robots.

- Refer to product catalogue, Operation Manual and Handling Precautions for SMC Products for additional information.
- Keep this manual in a safe place for future reference.

<b>Caution</b>	Caution indicates a hazard with a low level of risk which, if not avoided, could result in minor or moderate injury.
<b>Warning</b>	Warning indicates a hazard with a medium level of risk which, if not avoided, could result in death or serious injury.
<b>Danger</b>	Danger indicates a hazard with a high level of risk which, if not avoided, will result in death or serious injury.

## Warning

- Always ensure compliance with relevant safety laws and standards.
- All work must be carried out in a safe manner by a qualified person in compliance with applicable national regulations.
- If this equipment is used in a manner not specified by the manufacturer, the protection provided by the equipment may be impaired.

## Caution

- The product is provided for use in manufacturing industries only. Do not use in residential premises.

## 2 Specifications

## 2.1 Valve specifications

Size	30	40	50	60
Body material	Aluminum	Brass, Stainless steel		
Valve construction	Pilot operated diaphragm			
Valve type	Normally closed (N.C.)			
Fluid	Air, Water, Oil			
Maximum operating pressure [MPa]	1			
Withstand pressure [MPa]	2			
Ambient temperature [°C]	-20 to 60			
Fluid temperature [°C]	Air	-10 to 60 (Dew point temperature: -10 or lower)		
	Water	-	1 to 60 (No freezing)	
	Oil	-	-5 to 60 (Kinematic viscosity ≤ 50 mm <sup>2</sup> /s)	

## 2 Specifications - continued

Flow characteristics	Refer to catalogue
Response time [ms] <sup>Note 1)</sup>	Contact SMC
Duty cycle	100%
Min. operating frequency	1 cycle / 30 days
Max. operating frequency [Hz] <sup>Note 2)</sup>	2.5
Lubrication	Not required
Impact/Vibration resistance [m/s <sup>2</sup> ] <sup>Note 3)</sup>	150/30
Enclosure (based on IEC60529)	IP67 (DIN terminal IP65)
Mounting orientation	Unrestricted
Body materials	Aluminium, Brass, Stainless steel
Seal materials	NBR,FKM,EPDM
Weight	Refer to catalogue

Table 1.

Note 1) Variable dependent on pressure, voltage fluctuation, piping conditions, etc.  
Note 2) For reference only, based on response times when used with air:

Response time \ Size	30	40	50	60
ON [ms]	200	200	200	200
OFF [ms]	200	200	200	200

To be tested in actual application.

Note 3) Impact resistance: No malfunction occurred when it was tested with a drop tester in the axial direction and at right angles to the main valve and armature; in both energized and de-energized states and for every time in each condition. (Values quoted are for a new valve).

Vibration resistance: No malfunction occurred in a one-sweep test between 45 and 2000 Hz. Tests are performed at both energized and de-energized states in the axial direction and at right angles to the main valve and armature. (Values quoted are for a new valve).

## 2.2 Valve leakage and operating pressure differential

	Fluid	Body material	
		Aluminum	Brass, Stainless steel
Valve leakage [cm <sup>3</sup> /min] (ANR) <sup>Note 1)</sup>	Air	≤15	≤1
	Water, Oil	-	≤0.1
External leakage [cm <sup>3</sup> /min] (ANR) <sup>Note 1)</sup>	Air	≤15	≤1
	Water, Oil	-	≤0.1
Maximum operating pressure differential [MPa]	1		

Table 2.

Note 1) At 20°C ambient temperature and a differential pressure ≥ than the minimum operating pressure differential for air.

## 2.3 Solenoid specifications

Size	30	40	50	60
Coil rated voltage [V] <sup>Note 1)</sup>	AC	24, 48, 100, 110, 120, 200, 220, 230, 240		
	DC	12, 24		
Electrical entry	Grommet, Conduit, DIN terminal, M12 connector			
Coil insulation class	Class B			
Allowable voltage fluctuation	±10% of rated voltage			
Allowable leakage voltage	AC	5% or less of rated voltage		
	DC	2% or less of rated voltage		
Apparent power [VA] <sup>Note 2),3)</sup>	AC	9.5	16	
Power consumption [W] <sup>Note 2)</sup>	DC	8	13	
Temperature rise [°C] <sup>Note 4)</sup>	AC/DC	70/65	80/75	

Table 3.

- Note 1) Grommet with PCB, voltage AC110V or higher is not compatible with CE.  
Note 2) Apparent power / Power consumption values are at ambient temperature of 20°C and when rated voltage is applied (Variation: ± 10%).  
Note 3) There is no difference in the frequency and the inrush and energised apparent power, since a rectifying circuit is used in the AC.  
Note 4) Temperature rise is the increase when rated voltage is applied to a valve with an ambient temperature of 20°C. However, these values are for reference only as they vary depending on the surrounding environment.

## 2 Specifications - continued

## 2.4 Special products

## Warning

Special products (-X) might have specifications different from those shown in this section. Contact SMC for specific drawings.

## 3 Installation

## 3.1 Installation

## Warning

- Do not install the product unless the safety instructions have been read and understood.

## 3.2 Environment

## Warning

- Do not use in an environment where corrosive gases, chemicals, salt water or steam are present.
- Do not use in an explosive atmosphere.
- Do not expose to direct sunlight. Use a suitable protective cover.
- Do not install in a location subject to vibration or impact in excess of the product's specifications.
- Do not mount in a location exposed to radiant heat that would result in temperatures in excess of the product's specifications.
- Products compliant with IP65 and IP67 enclosures are protected against dust and water, however, these products cannot be used in water.
- Products compliant with IP65 and IP67 enclosures satisfy the specifications by mounting each product properly. Be sure to read the Specific Product Precautions for each product.

## 3.3 Piping

## Caution

- Before connecting piping make sure to clean up chips, cutting oil, dust etc.
- When installing piping or fittings, ensure sealant material does not enter inside the port. When using seal tape, leave 1.5 to 2 thread exposed on the end of the pipe/fitting.
- Tighten fittings to the specified tightening torque.

Connection thread	Tightening torque [N·m]
Rc 1/4	12 to 14
Rc 3/8	22 to 24
Rc 1/2	28 to 30
Rc 3/4	28 to 30
Rc 1	36 to 38

Table 4.

- When using SMC fittings, please refer to Fittings and Tubing Precautions in the Handling Precautions for SMC products.
- When using fittings other than SMC fittings, follow the instructions given by the fitting manufacturer.

## 3.3.1 Recommended piping conditions

## Caution

- When connecting tubes using one-touch fittings, provide some spare tube length as shown in Fig 1.
- Do not apply external force to the fittings when binding tubes with bands.

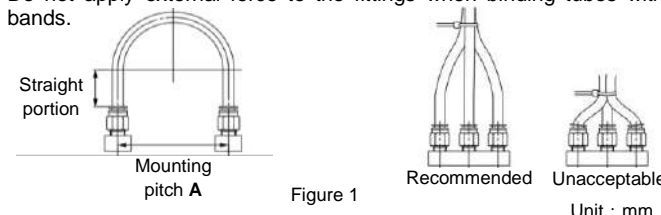

Figure 1

Tube size	Mounting pitch A			Straight line length
	Nylon tube	Soft nylon tube	Polyurethane tube	
Ø 1/8"	44 or more	29 or more	25 or more	16 or more
Ø 6	84 or more	39 or more	39 or more	30 or more
Ø 1/4"	89 or more	56 or more	57 or more	32 or more
Ø 8	112 or more	58 or more	52 or more	40 or more
Ø 10	140 or more	70 or more	69 or more	50 or more
Ø 12	168 or more	82 or more	88 or more	60 or more

Table 5.

## 3 Installation - continued

## 3.4 Lubrication

## Caution

- SMC products have been lubricated for life at manufacture, and do not require lubrication in service.
- If a lubricant is used in the system, refer to catalogue for details.

## 3.5 Fluid supply

## Warning

- The use of a fluid that contains foreign matter can cause problems, such as malfunction and seal failure by promoting the wear of the valve seat and armature, by sticking to the sliding parts of the armature, etc. Install a suitable filter (strainer) immediately upstream of the valve. Select a filter with a filtration size of 5 µm or smaller for air, and 100 mesh for water.
- If there is a possibility of back pressure being applied to the valve, take countermeasures such as mounting a check valve on the downstream side of the valve.

## 3.5.1 Air

## Warning

- Use clean air. If the compressed air supply includes chemicals, synthetic materials (including organic solvents), salinity, corrosive gas etc., it can lead to damage or malfunction.
- Compressed air that includes excessive drainage may cause the malfunction of valves and other pneumatic equipment. Install an aftercooler or an air dryer on the inlet side of the valve as a countermeasure against drainage.
- If excessive carbon powder is generated by the compressor, it may adhere to the inside of the valves and cause a malfunction. Install a mist separator on the inlet side of the valve as a countermeasure to remove any carbon powder.
- When operating fluid air with a dew point of -70°C or lower, the inside of the valve may wear, and the product life will be shortened.

## 3.5.2 Water

## Warning

- Be aware that rust stains, chloride separation, etc., from the piping may cause malfunction, leakage, or, in worse case scenarios, damage due

to corrosion. Also, such damage may result in the spraying of fluids or scattering of parts. Please be sure to have protective measures in place in case such incidents should occur.

- In the case that water contains substances such as calcium and magnesium, which generate hard scale and sludge, install water softening equipment and a filter (strainer) directly upstream from the valve to remove these substances, as this scale and sludge can cause the valve to malfunction.
- The water pressure of tap water is usually 0.4 MPa or less, but the pressure can sometimes increase to 1.0 MPa in tall buildings. Therefore, pay attention to the max. operating pressure differential.

## 3.5.3 Oil

## Warning

Generally, FKM is used as seal material, as it is resistant to oil. However, the resistance of the seal material may deteriorate depending on the type of oil, manufacturer, or additives. Check the resistance before using. The kinematic viscosity of fluid must not exceed 50 mm<sup>2</sup>/s.

## 3.6 Mounting

## Caution

- When mounting the valve to a bracket, tighten the mounting bolts to the following tightening torques.

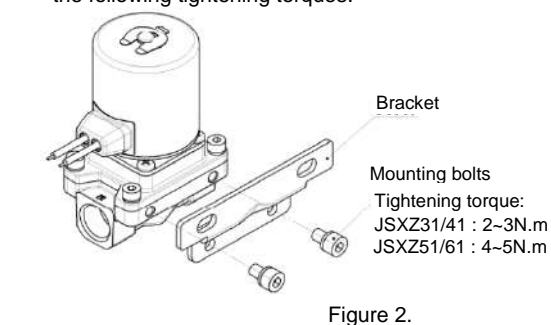

Figure 2.

### 3 Installation – continued

- The bracket is shipped together with the product.
- For JSXZ51 / 61, the mounting bolts and washers are separate. Please be careful not to lose the washers.

Size	Port size	Bracket assembly part no. (With screws)
30/40	1/4, 3/8, 1/2	VXZ30S-14A-1
50/60	3/4, 1	VXZ50S-14A-1

Table 6.

#### 3.7 Electrical connection

##### Warning

- The solenoid valve is an electrical product. For safety, install an appropriate fuse and circuit breaker before use according to local regulations. When using a number of solenoid valves, installing one fuse on the primary side is not enough. To protect the device more safely, select and install a fuse for each circuit.

##### Caution

- Avoid mis-wiring, as this can cause malfunction and damage to the product.
- Use electrical wire with cross sectional area 0.5 to 1.25 mm<sup>2</sup>.
- Use electrical circuits that do not generate chattering in their contacts.
- When a surge from the solenoid affects the electrical circuitry, install a surge absorber, etc., in parallel with the solenoid or use the product with a surge voltage suppressor.
- Use voltage that is within ±10% of the rated voltage. In case of direct current, if the response time is important, ensure that voltage is within ±5% of the rated value. (The voltage drop is the value in the lead wire section connecting the coil.)
- Do not bend or pull lead wires and cables repeatedly.
- Do not apply more than 10 N of force to the lead wires or damage may occur.

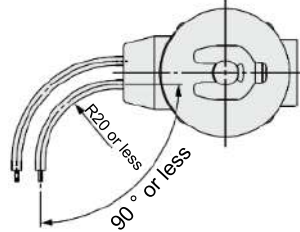

Figure 3. Lead wire bending

- Do not bend the lead wires beyond 90° with a radius of less than 20mm or damage may occur. See figure 4.

#### 3.7.1 Grommet (Lead wire AWG20, outer diameter 2.6 mm.)

Voltage type		Lead wire colour	
		1	2
Grommet	DC (12, 24 V)	Black	Red
	DC (12, 24 V)	Black	Red
Grommet with PCB	AC (100 V)	Blue	Blue
	AC (24, 48 V)	Grey	Grey

Table 7.

Note : There is no polarity.

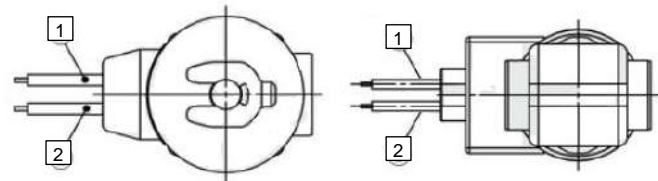

Figure 4. Grommet and Grommet with PCB

#### Conduit (Lead wire AWG18, outer diameter 2.8 mm.)

Voltage type	Conduit wire colour		
	1	2	3 (ground wire)
DC	Black	Red	Green / Yellow
AC 100V	Blue	Blue	Green / Yellow
AC 200V	Red	Red	Green / Yellow
Other AC	Grey	Grey	Green / Yellow

Table 8.

Note : There is no polarity.

### 3 Installation - continued

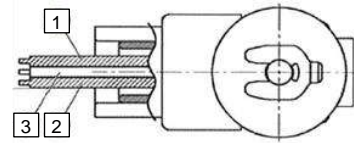

Figure 5. Conduit

#### 3.7.2 DIN terminal

- Use a cord with an outside cable diameter of Ø6 to Ø12 mm.
- Tighten screws and fittings according to Figure 7.
- If an outside cable diameter of Ø9 to Ø12 mm is used, remove the internal parts of the rubber seal before using.

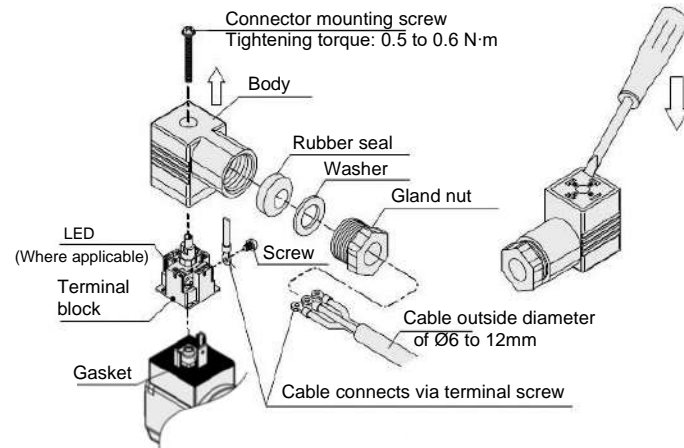

Figure 6. DIN connector construction

- Conforms to DIN EN 175301-803, 18 mm, Form A.

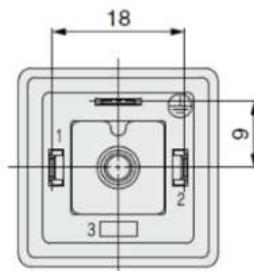

Figure 7. DIN terminal - Form A

##### Caution

Internal connections are shown below. Make connections to the power supply accordingly.

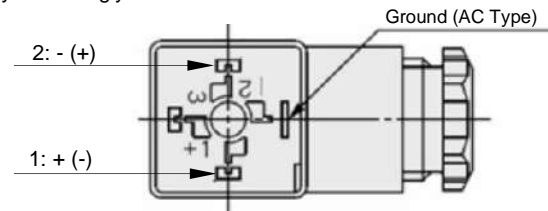

Figure 8. DIN connector pins

Note: There is no polarity.

Contact	1	2
DIN Terminal	+ (-)	- (+)

Table 9.

##### Warning

The ground terminal is connected to the coil assembly only and does not provide a protective earth for the body of the valve.

### 3 Installation - continued

#### 3.7.3 M12 connector

Valve side			
DC (non-polar)		AC	
2. Unused	1. Unused	2. Unused	1. Earth
3. Power	4. Power	3. Power	4. Power

Table 10.

Cable side			
DC (non-polar)		AC	
1. Unused	2. Unused	1. Earth	2. Unused
4. Power	3. Power	4. Power	3. Power

Table 11.

M12 connector wire colour			
1	2	3	4
Brown	White	Blue	Black

Table 12.

##### Caution

- The valve achieves IP67 rating when used with IP67 rated female connector (with cable). Note that the valve shouldn't be used in water.
- Tighten the connector by hand (at 0.39 to 0.49 N·m), not with a tool which may damage the connector.
- Do not apply repeated bending force, tensile force or heavy load to the cable.
- Do not pull the connector or cable unnecessarily.
- When installing the valve, do not bend the cable at the root from the connector body.

#### 3.8 Electrical circuits

##### 3.8.1 DC circuits

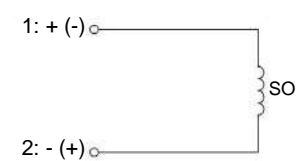

Figure 9. Grommet without electrical option

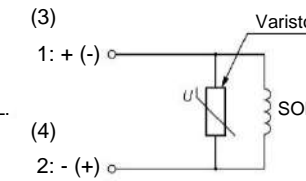

Figure 10. Grommet / DIN terminal / Conduit with surge voltage suppressor / M12 connector (3,4)

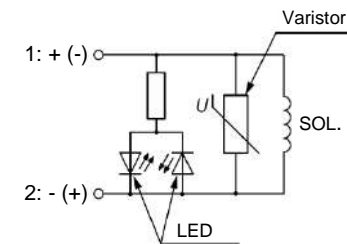

Figure 11. DIN terminal with LED and surge voltage suppressor

##### 3.8.2 AC circuits

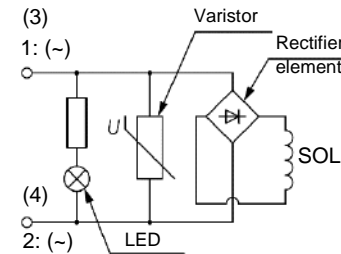

Figure 12. DIN terminal with LED and surge voltage suppressor

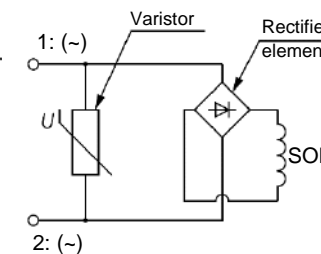

Figure 13. Grommet / DIN terminal / Conduit with surge voltage suppressor / M12 connector (3,4)

### 3 Installation - continued

#### 3.9 Residual voltage

##### Caution

- If a varistor or diode surge voltage suppressor is used, the suppressor arrests the back EMF voltage from the coil to approximately 1 V (AC type) or 60 V (DC type).
- Ensure the transient voltage is within the specification of the host controller.
- Valve response time is dependent on surge suppression method selected.

#### 3.10 Countermeasure for surge voltage

##### Caution

- At times of sudden interruption of the power supply, the energy stored in a large inductive device may cause non-polar type valves in a de-energised state to switch.
- When installing a breaker circuit to isolate the power, install a surge absorption diode across the output of the breaker.

#### 3.11 Extended period of continuous energization

##### Warning

- The solenoid coil will generate heat when continuously energized so avoid installing in an enclosed space. Install the valve in a well-ventilated area.
- Do not touch the coil while it is being energized or immediately after energization.

### 4 How to Order

Refer to catalogue for 'How to Order'.

### 5 Outline Dimensions

Refer to catalogue for outline dimensions.

### 6 Maintenance

#### 6.1 General maintenance

##### Caution

- Not following proper maintenance procedures could cause the product

to malfunction and lead to equipment damage.

- If handled improperly, compressed air can be dangerous. Shut off the fluid supply and release the fluid pressure in the system.
- Make sure that temperature of the valve has reduced sufficiently before removing the valve.
- Maintenance of pneumatic systems should be performed only by qualified personnel.
- Before performing maintenance, turn off the power supply and be sure to cut off the supply pressure. Confirm that the air is released to atmosphere.
- After installation and maintenance, apply operating pressure and power to the equipment and perform appropriate functional and leakage tests to make sure the equipment is installed correctly.
- If any electrical connections are disturbed during maintenance, ensure they are reconnected correctly, and safety checks are carried out as required to ensure continued compliance with applicable national regulations.
- Do not make any modification to the product.
- Do not disassemble the product, unless required by installation or maintenance instructions.
- Periodic maintenance of filter and strainer:
  - Replace filter element every 1 year or when the pressure drop becomes 0.1 MPa, whichever comes first.
  - Wash strainer when the pressure drop becomes 0.1 MPa.
- Exhaust the drainage from the air filters periodically. If the drainage overflows and enters the air line, this may cause malfunction of pneumatic equipment.

#### 6.2 Storage

##### Caution

In the case of long term storage, thoroughly remove all moisture to prevent rust and deterioration of rubber materials, etc.

### 7 Limitations of Use

#### 7.1 Limited warranty and disclaimer/compliance requirements

Refer to Handling Precautions for SMC Products.



## 7 Limitations of Use – continued

### Warning

#### 7.2 Effect of energy loss on valve switching

Fluid supply present, electrical supply cut	The valve returns to the OFF position by the return spring force and the pressure above the diaphragm in the pressure chamber.
Electrical supply present, fluid supply cut	Valve remains in the ON position.

Table 13.

- Unstable flow may occur with the product under the following conditions: low flow from the pump or compressor, use of several elbows or tees in the circuit, thin nozzles installed at the end of the piping, etc. This can cause valve opening/closing failure, or oscillation, and cause a valve malfunction. If products are used with vacuum, then the vacuum level can be unstable due to these conditions.

#### 7.3 Low temperature operation

- The valve can be used in an ambient temperature up to -20°C. However, take measures to prevent freezing or solidification of impurities, etc.
- When using valves for water application in cold climates, take appropriate countermeasures to prevent the water from freezing in tubing after cutting the water supply from the pump, by draining the water, etc.
- When warming by a heater, etc., be careful not to expose the coil portion to a heater. Installation of a dryer, heat retaining of the body is recommended to prevent freezing condition in which the dew point temperature is high, and the ambient temperature is low, and the high flow runs.

#### 7.4 Holding of pressure

Since valves are subject to air leakage, they cannot be used for applications such as holding pressure (including vacuum) in a system.

#### 7.5 Cannot be used as an emergency shut-off valve

This product is not designed for safety applications such as an emergency shut-off valve. If the valves are used in this type of system, other reliable safety assurance measures should be adopted.

#### 7.6 Closed circuit

In a closed circuit, when liquid is static, pressure could rise due to changes in temperature. This pressure rise could cause malfunction and damage to components such as valves. To prevent this, install a relief valve in the system.

#### 7.7 Impact by rapid pressure fluctuation

- When an impact caused by the rapid pressure fluctuation, such as water hammer etc., is applied, the solenoid valve may be damaged. Install water hammer relief equipment (accumulator, etc.), or use a SMC water hammer relief valve (e.g. VXR series).
- If the product is used in the conditions in which rapid decrease in the inlet pressure of the valve and rapid increase in the outlet pressure of the valve are repeated, excessive stress will be applied to the diaphragm, which can cause the diaphragm to be damaged and dropped.
- For pilot operated 2-port solenoid valves, when the valve is closed, sudden pressure resulting from the start-up of the fluid supply source (pump, compressor, etc.) may cause the valve to open momentarily and leakage to occur, so please exercise caution.

#### 7.8 Normally closed valves

Although the valves are normally closed (IN and OUT port blocked), and flow is blocked from Port 1 to Port 2, the fluid will not be blocked if Port 2 pressure is greater than Port 1 pressure, and fluid will flow from Port 2 to Port 1.

### Caution

#### 7.9 Leakage voltage

Ensure that any leakage voltage caused by the leakage current when the switching element is OFF causes  $\leq 5\%$  (for DC coils) or  $\leq 2\%$  (for AC coils) of the rated voltage across the valve.

#### 7.10 Fluids

- The compatibility of the components of this product with the fluid used may vary depending on the type of fluid, additives, concentration, temperature, etc. Check the compatibility with the actual machine before use.

## 7 Limitations of Use – continued

- Take measures to prevent static electricity since some fluids can cause static electricity.
- Do not use the product with the fluids listed below:
  - Fluids that are harmful to the human body.
  - Combustible or flammable fluids.
  - Corrosive gas and fluid.
  - Sea water, saline.

## 8 Product Disposal

This product shall not be disposed of as municipal waste. Check your local regulations and guidelines to dispose this product correctly, in order to reduce the impact on human health and the environment.

## 9 Return of Product

### Warning

If the product to be returned is contaminated or is possibly contaminated with substances that are harmful to humans, for safety reasons, please contact SMC beforehand and then employ a specialist cleaning company to decontaminate the product. After the decontamination prescribed above has been carried out, submit a Product Return Request Sheet or the Detoxification/Decontamination Certificate to SMC and await SMC's approval and further instructions before attempting to return the item. Please refer to the International Chemical Safety Cards (ICSC) for a list of harmful substances. If you have any further questions, please don't hesitate to contact your SMC sales representative.

## 10 Contacts

Refer to [www.smcworld.com](http://www.smcworld.com) or [www.smc.eu](http://www.smc.eu) for your local distributor/importer.

## SMC Corporation

URL : <https://www.smcworld.com> (Global) <https://www.smc.eu> (Europe)  
 SMC Corporation, 4-14-1, Sotokanda, Chiyoda-ku, Tokyo 101-0021, Japan  
 Specifications are subject to change without prior notice from the manufacturer.  
 © 2022 SMC Corporation All Rights Reserved.  
 Template: DKP50047-F-085M